



MÜLLER VIBRATION TECHNOLOGY TECHNICAL DATA

Optimal machinery and equipment are the key to cost-effective work in marine and foundation engineering projects.

We supply our customers with the complete range of machinery and equipment for driving steel sheet piles, tubular piles, beams, and other piling sections for light to heavy pile driving jobs. We also provide a convincing technical concept and ensure that the project is executed cost-effectively.

There is a wide range of technologies available for installing piles: driving and extracting, pressing, hammering or drilling. Depending on the on-site requirements, we offer our customers a broad spectrum of suitable machinery, with a range of variants and performance variables, turning as well to our own products such as MÜLLER pile driving and extracting equipment and our drill drives.

Contents

02	Characteristics
02	Selection guide
03	Operating principle of MÜLLER vibratory hammers
04	Principle of resonance-free starting and stopping
05	MÜLLER vibratory hammers H series
06	MÜLLER vibratory hammers HHF series
07	MÜLLER vibratory hammers HFV series
08	MÜLLER power packs
09	MÜLLER excavator-mounted vibratory hammers HFB series
10	MÜLLER excavator-mounted vibratory hammers HFB S series
11	MÜLLER excavator-mounted vibratory hammers HFBV series
12	MÜLLER side-grip excavator-mounted vibratory hammers HFB SG series
13	MÜLLER excavator-mounted drill drives
14	MÜLLER clamping devices
15	MÜLLER accessories

Characteristics

The selection of a suitable vibratory hammer depends mainly on the size and weight of the pile, the driving depth and the existing soil. In principle, the centrifugal force and amplitude must be selected so that the surface friction and the tip resistance between the pile and the surrounding soil can be overcome.

Selection guide

The selection guide below helps to choose the right vibratory hammer or determine the centrifugal force required depending on soil conditions, pile weight, and driving depth.

The use of additional equipment, e.g., flushing lances or pre-drilling units, can help to achieve much better driving performance with the same size or centrifugal force of the vibratory hammer.

The power pack must be powerful enough to provide the necessary working torque to ensure the centrifugal force of the vibratory hammer, even in difficult soils. The drive output should be 2-3 kW per 10 kN centrifugal force.

For an exact equipment selection, depending on soil parameters and pile section data, please contact our technical consultants. They will use numerical simulation software to calculate the optimum machine for your application.

Equipment selection guide

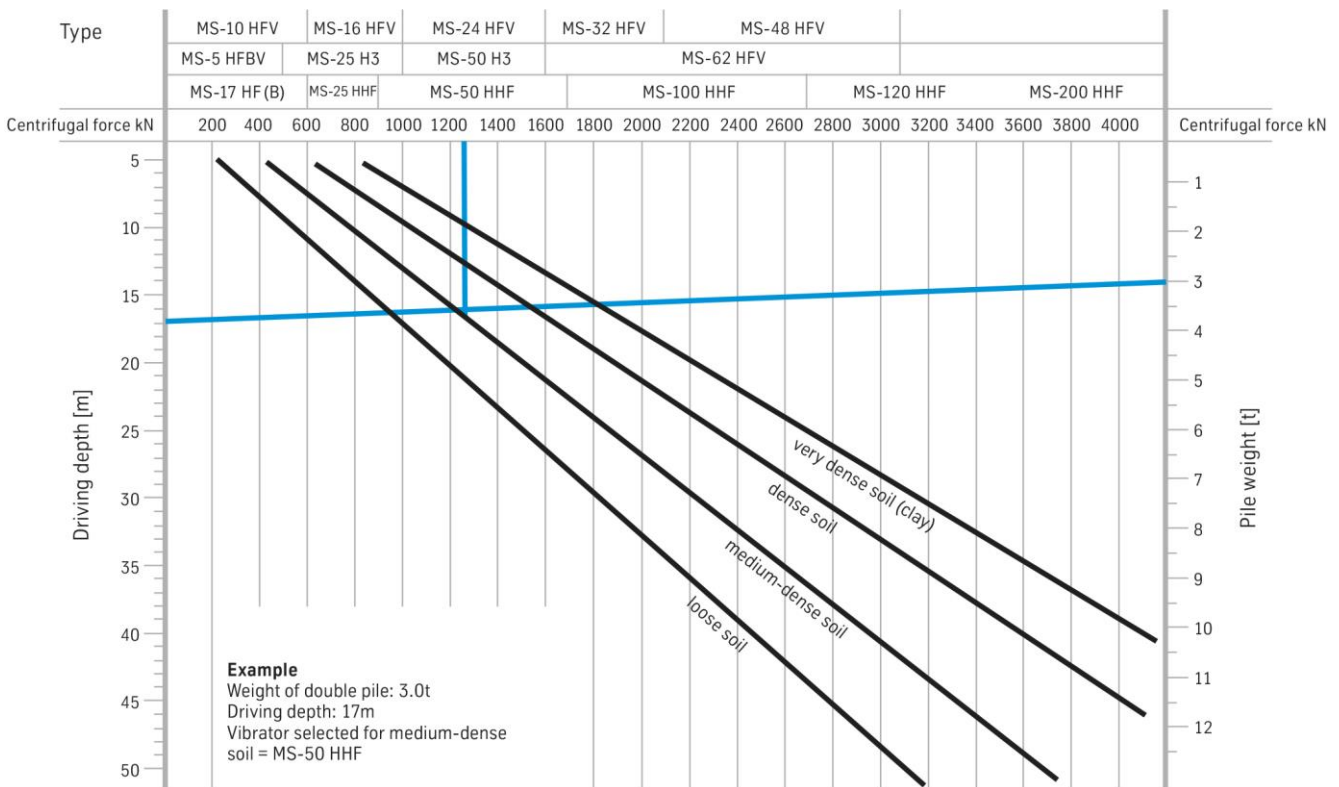

Operating principle of MÜLLER vibratory hammers (typical design)

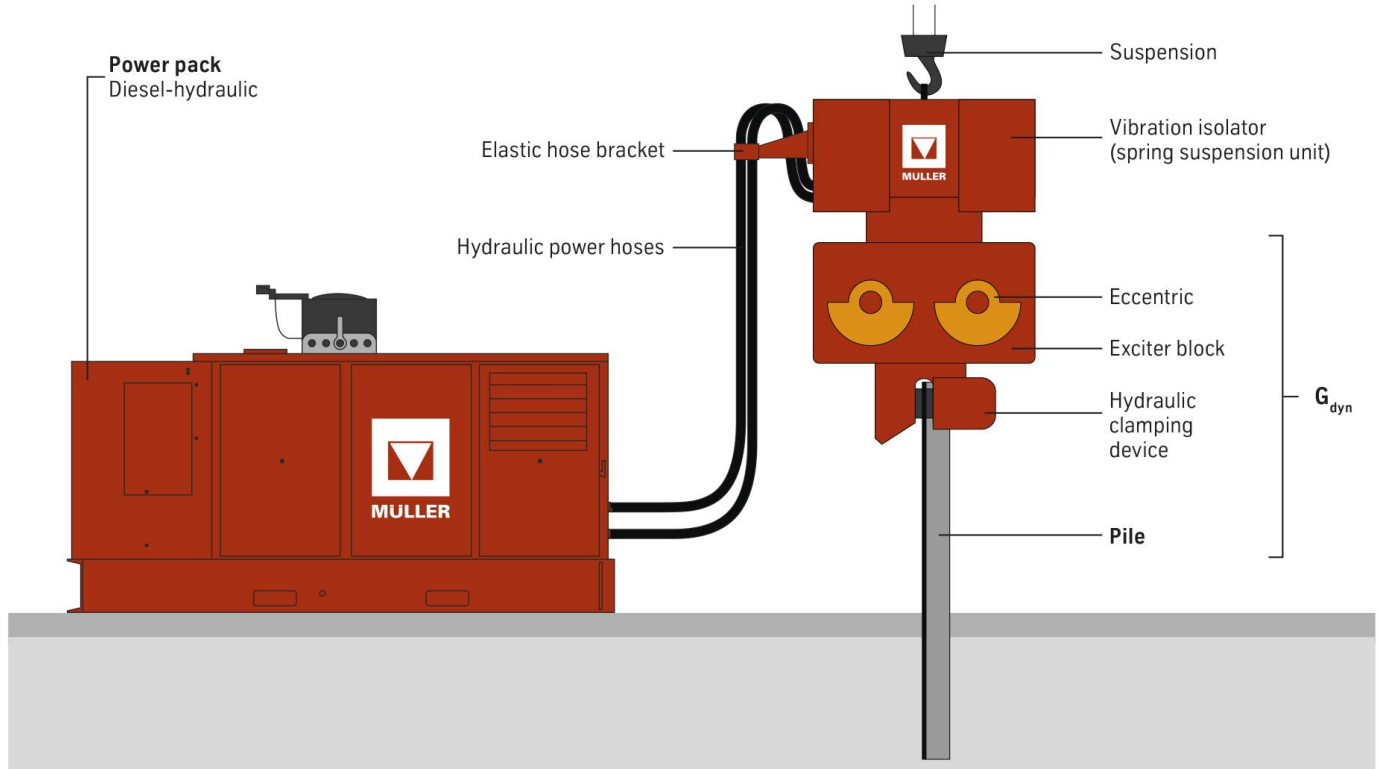

Key vibration technology data

Eccentric moment M [kgm]

$$M = G \cdot r$$

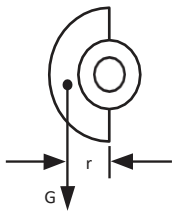

The eccentric moment is the measure of unbalance. As a determining factor for amplitude it is a key parameter for driving operations.

Speed (frequency) n [rpm]

The speed dictates the vibration frequency of the system. The vibrations are transferred via the pile to the surrounding soil, significantly reducing the surface friction between pile and soil. High frequencies counter the unwanted spread of vibrations in the soil.

Centrifugal force F [N]

$$F = M \cdot \omega^2$$

$$F = M \cdot \left(\pi \cdot \frac{n}{30}\right)^2$$

The centrifugal force must be high enough to overcome surface friction between pile and soil. Centrifugal force plays a major part in reducing surface friction and provides impact force to overcome tip resistance.

Amplitude S [m]

$$S = 2s = \frac{2 \cdot M_{stat} [kgm]}{G_{dyn} [kg]}$$

Together with centrifugal force, amplitude is a measure of driving performance. A large 'stroke' and high 'impact force' ensure good driving progress. When driving and extracting in cohesive soils, the elastic connection between pile and soil can only be overcome, if the amplitude is high enough.

Acceleration a [m/s²]

$$a = s \cdot \omega^2 \text{ with } \omega = \pi \cdot \frac{n}{30}$$

Transmission of the pile acceleration to the surrounding soil causes the displacement of the grain structure and reduces grain friction and soil resistance. Acceleration is expressed as the ratio of acceleration of the vibrator to gravity:

$$\eta = \frac{a}{g} \text{ This ratio corresponds to: } \eta = \frac{F \cdot 10^{-1}}{G_{dyn}}$$

The value can lie between 10 and 30.

Principle of resonance-free starting and stopping

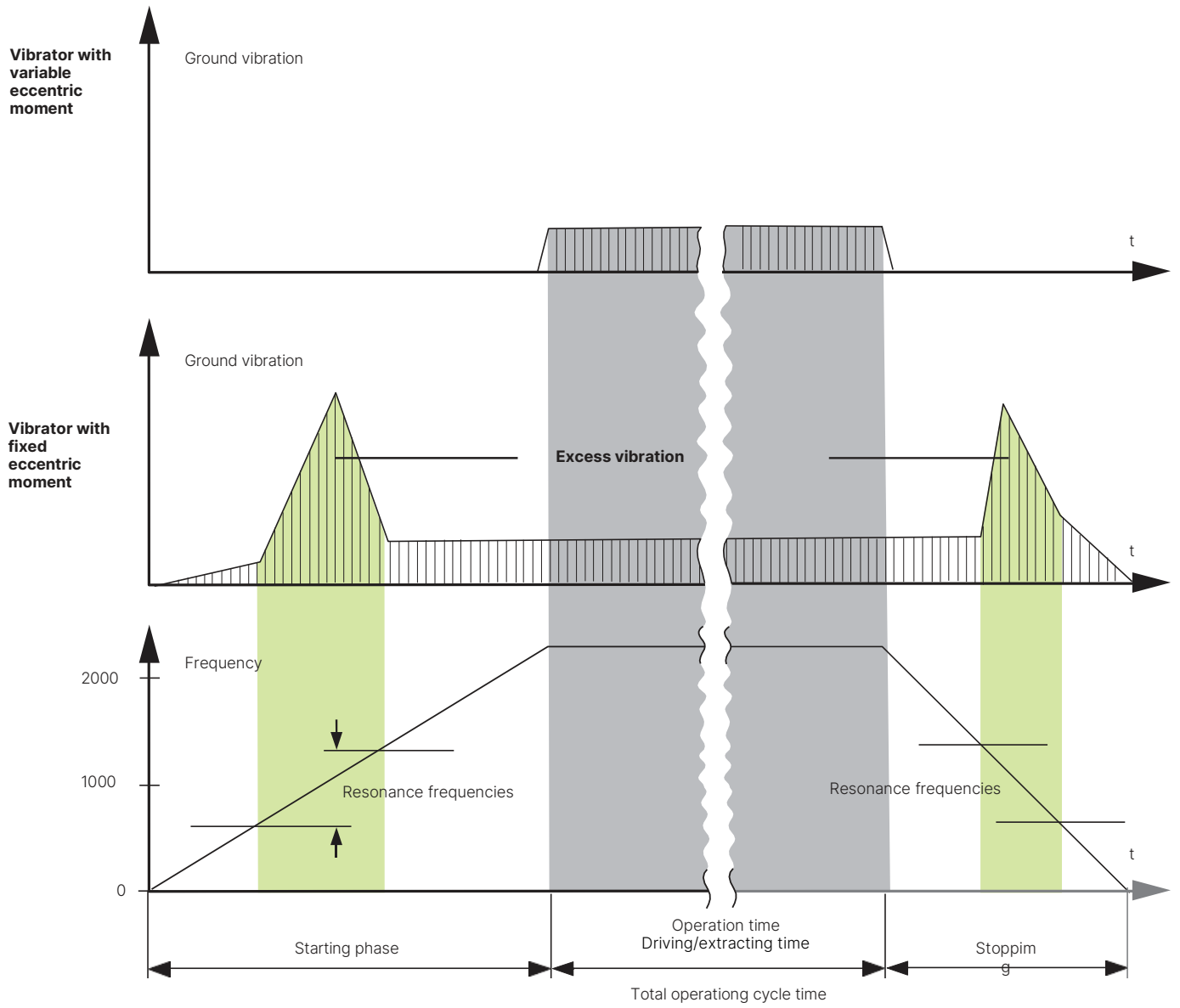

MÜLLER vibratory hammers H series

Type			MS-25 H3	MS-35 H3	MS-50 H3	MS-65 H3
Centrifugal force	F (max.)	kN	774	834	1430	1670
Eccentric moment	M stat	kgm	25	32,5	50	65
Frequency	f (max.)	min ⁻¹	28.0	25.5	26.9	25.5
Speed	n (max.)	Hz	1,680	1,530	1,615	1,530
Pulling force	F pull (max.)	kN	400	400	500	500
Weight total	without clamping device	kg	3,600	3,600	7,905	8,200
Weight dynamic	without clamping device	kg	2,550	2,660	3,820	4,200
Amplitude	without clamping device/pile	mm	19.6	24.4	26.2	31.0
Power consumption	P (max.)	kW	248	270	419	450 / 397
Required oil flow	Q motor (max.)	l/min	425	463	719	773 / 680
Operating pressure	p (max.)	bar	350	350	350	350
Dimensions	Length L	mm	2,250	2,250	2,800	2,800
	Width B	mm	761	761	722	737
	Height H	mm	1,760	1,760	2,140	2,140
	Throat T	mm	402	402	402	402
Single clamping device	Type	MS-U	80/100	80/100	180	200
	alternative	MS-U	150	150	–	250
Double clamping device	Type	MS-U	2 x 54	2 x 54	2 x 80/100	2 x 80/100
	alternative	MS-U	2 x 90	2 x 90	2 x 90	–
Recommended power pack	Type	MS-A	340 o. 280	340 o. 280	420	580 o. 570 / 420

Fixed eccentric moment

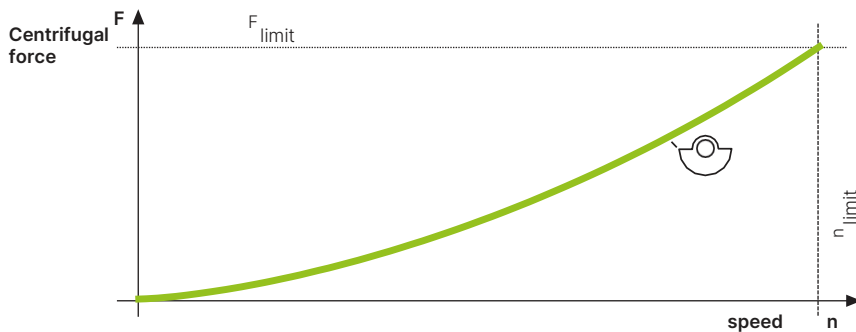

MÜLLER vibratory hammers HHF series

Type			MS-25 HHF	MS-50 HHF	MS-100 HHF	MS-120 HHF	MS-220 HHF	MS-240 HHF
Centrifugal force	F (max.)	kN	750	1,500	2,500	3,003	4,686	5,160
Eccentric moment	M stat (max.)	kgm	25	50	100	116	218	240
	Steps (see illustration)	kgm	12 / 15 / 20 / 25	24 / 30 / 40 / 50	48 / 60 / 80 / 100	80 / 94 / 110 / 116	151 / 175 / 193 / 218	151 / 193 / 218 / 240
Frequency steps	f (max.)	Hz	38 / 35,2 / 30,5 / 27,3	39,3 / 35,2 / 30,5 / 27,3	36 / 32 / 27,8 / 25	30,9 / 28,3 / 26,2 / 25,6	27,5 / 26 / 24,5 / 23,3	29,5 / 26 / 24,5 / 23,3
Speed steps	n (max.)	min ⁻¹	2,280 / 2,113 / 1,830 / 1,637	2,362 / 2,113 / 1,830 / 1,637	2,160 / 1,920 / 1,670 / 1,500	1,850 / 1,700 / 1,570 / 1,536	1,650 / 1,560 / 1,470 / 1,400	1,770 / 1,560 / 1,470 / 1,400
Pulling force	F pull (max.)	kN	280	500	600	1.200	1.200	1.200
Weight total	without clamping device	kg	3.700	6.100	10.900	15.500	20.100	20.100
Weight dynamic	without clamping device	kg	2.900	4.500	7.700	8.900	11.980	12.010
Amplitude	without clamping device / pile	mm	8.3 / 10.3 / 13.8 / 17.2	10.7 / 13.3 / 17.8 / 22.2	12.5 / 15.6 / 20.8 / 26.0	18.0 / 21.1 / 24.7 / 26.1	25.2 / 29.2 / 32.2 / 36.4	25.1 / 32.1 / 36.3 / 40.0
Power consumption	P (max.)	kW	290	562 / 356	750 / 610	895 / 671	1,015	1,032
Required oil flow	Q Motor (max.)	l/min	495	964 / 610	1,286 / 1,045	1,534 / 1,150	1,740	1,770
Operation pressure	p (max.)	bar	350	350	350	350	350	350
Dimensions	Length L	mm	1,800	2,260	2,410	2,310	2,300	2,300
	Width B	mm	813	888	846	1,200	1,513	1,513
	Height H	mm	1,885	2,465	3,235	4,135	4,190	4,190
	Throat T	mm	360	350	500	832	832	832
Single clamping device	Type	MS-U	80/100	180	360	360	360*	360*
	alternative	MS-U	90	200	-	-	-	-
Double/quadruple clamping device	Type	MS-U	2 x 54	2 x 80/100	2 x 150	2 x 180	4 x 150	4 x 180
	alternative	MS-U	-	-	2 x 180	2 x 150*	4 x 180	4 x 150*
	alternative	MS-U	-	-	-	-	2 x 250*	2 x 250*
Recommended power pack	Type	MS-A	340 o. 280	580 o. 570 / 420	840 / 690 o. 700	1200 o. 1150 / 840	1200 o. 1150	1200 o. 1150

* Only permitted with reduced centrifugal force

Stepwise adjustable eccentric moment

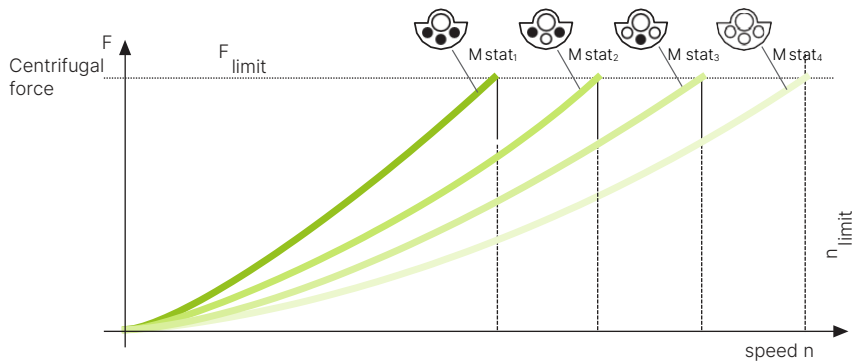

MÜLLER vibratory hammers HFV series

Type			MS-10 HFV	MS-12 HFV	MS-16 HFV	MS-20 HFV	MS-24 HFV	MS-28 HFV	MS-32 HFV	MS-40 HFV	MS-48 HFV	MS-62 HFV
Centrifugal force	F (max.)	kN	610	739	986	1,230	1,480	1,473	1,980	2,006	2,960	2,998
Eccentric moment	M stat (variable)	kgm	0-10	0-12.3	0-16	0-19.5	0-24	0-28	0-32	0-39.2	0-48	0-62
Frequency	f (max.)	Hz	39.3	39.0	39.5	40.0	39.2	36.5	39.6	36.0	39.0	35.0
Speed	n (max.)	min ⁻¹	2,358	2,340	2,370	2,400	2,350	2,190	2,375	2,160	2,350	2,100
Pulling force	F pull (max.)	kN	180	210	300	300	400	500	600	600	600	800
Weight total	without clamping device	kg	2,350	2,350	3,530	3,600	5,150	5,200	7,250	7,430	9,700	11,165
Weight dynamic	without clamping device	kg	1,750	1,750	2,565	2,530	2,900	2,950	4,850	5,020	6,520	6,805
Amplitude	without clamping device/pile	mm	11.8	14.1	12.5	15.4	16.5	18.0	13.2	15.6	14.7	18.2
Power consumption	P (max.)	kW	147 / 203	275 / 293	297 / 408	300 / 413	404 / 551	428 / 514	610 / 685	630 / 756	823 / 682	980 / 735
Required oil flow	Q Motor (max.)	l/min	253 / 348	471 / 502	508 / 699	515 / 708	693 / 945	734 / 880	1,045 / 1,175	1,080 / 1,296	1,410 / 1,170	1,680 / 1,260
Operating Pressure	p (max.)	bar	350	350	350	350	350	350	350	350	350	350
Dimensions	Length L	mm	1,797	1,797	2,080	2,080	2,110	2,110	2,465	2,465	2,465	2,465
	Width B	mm	732	789 / 839	782	782	866 / 956	866 / 956	800	826	1,123	1,180
	Height H	mm	1,560	1,560	2,060	2,060	2,210	2,240	2,455	2,460	2,525	2,525
	Throat T	mm	330	330	350	350	451	451	345	437	860	860
Single clamping device	Type	MS-U	80/100	80/100	150	150	180	180	250	250	360	360
Double clamping device	Type	MS-U	2 x 54	2 x 54	2 x 90	2 x 90	2 x 90	2 x 90	2 x 150	2 x 150	2 x 180	2 x 180
Recommended power pack	Type	MS-A	190	280	340 o.280	340 o.280	420	420	580 o.570	690 o.700	840	1200 o.1150
	Type	MS-A	280	340	420	420	580 o.570	580 o.570	700	840	700	840

Variable eccentric moment

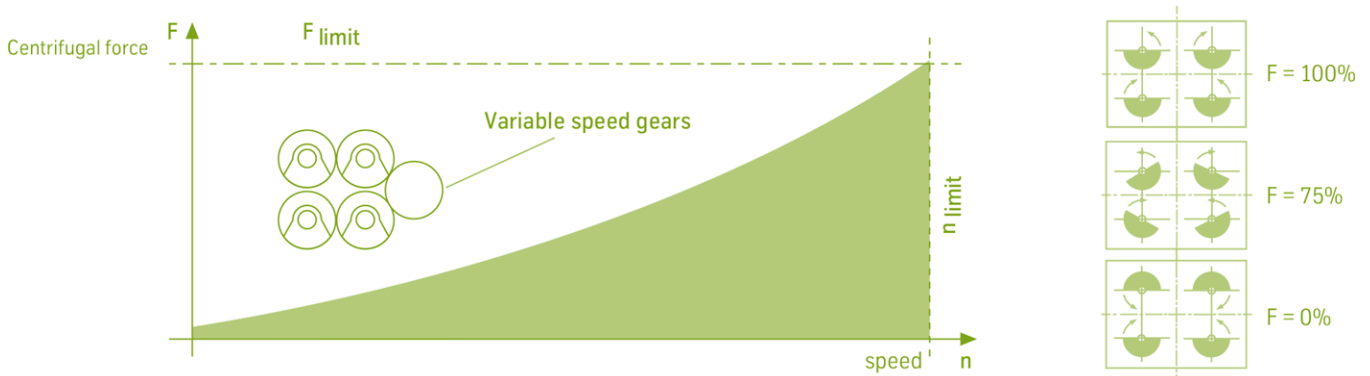

MÜLLER power packs

EU Stage V / EPA Tier 4 final exhaust certifications

Type			MS-A 190 V	MS-A 340 V	MS-A 420 V	MS-A 580 V	MS-A 690 V	MS-A 840 V	MS-A 1200 V
Diesel engine			CAT	CAT	CAT	CAT	CAT	CAT	Volvo Penta
Type			C 7.1	C 9.3B	C 15	2x C 9.3B	2x C 9.3B	2x C 15	2x TWD 1683 VE
Exhaust certification		EU / EPA	V / Tier 4f	V / Tier 4f	V / Tier 4f	V / Tier 4f	V / Tier 4f	V / Tier 4f	V / Tier 4f
Power	P (max.)	kW	186	340	433	560	680	866	1,170
Speed	n (max.)	min ⁻¹	2,000	2,000	2,000	2,000	2,000	2,000	1,800
Hydraulics									
Oil flow rate	Q (max.)	l/min	290	530	740	1,080	1,080	1,480	1,980
Operating pressure	p (max.)	bar	380	380	380	380	380	380	380
Fuel tank capacity		l	400	800	900	1,400	1,400	2,200	2,200
Hydraulic tank capacity		l	500	220	280	500	500	600	600
Weight without fuel		kg	4,700	5,600	6,800	10,600	10,600	14,000	15,500
Dimensions	Length L	mm	3,000	3,950	4,250	4,800	4,800	5,300	6,300
	Width B	mm	1,500	1,550	1,700	2,200	2,200	2,400	2,400
	Height H	mm	2,220	2,200	2,450	2,365	2,365	2,600	2,595

Other exhaust certifications

Type			MS-A 280 V	MS-A 420 V	MS-A 570 V	MS-A 700 V	MS-A 840 V	MS-A 1150 V	
Diesel engine			CAT	CAT	Volvo Penta	CAT	CAT	Volvo Penta	
Type			C 9.3B LRC	C 15	TAD 1643 VE	2x C 13	2x C 15	2x TAD1643 VE	
Exhaust certification		EU / EPA	IIIA / Tier 3	IIIA / Tier 3	II / Tier 2	IIIA / Tier 3	IIIA / Tier 3	II / Tier 2	
Power	P (max.)	kW	280	433	565	708	866	1,130	
Speed	n (max.)	min ⁻¹	2,200	2,000	1,850	2,100	2,000	1,850	
Hydraulics									
Oil flow rate	Q (max.)	l/min	525	740	1,050	1,180	1,480	2,100	
Operating pressure	p (max.)	bar	380	380	380	380	380	380	
Fuel tank capacity		l	750	900	1,050	1,400	2,200	2,200	
Hydraulic tank capacity		l	230	280	440	500	600	600	
Weight without fuel		kg	5,300	6,200	8,500	10,300	12,500	13,800	
Dimensions	Length L	mm	3,950	4,250	4,750	4,800	5,300	5,300	
	Width B	mm	1,480	1,700	2,000	2,200	2,400	2,400	
	Height H	mm	2,400	2,450	2,370	2,450	2,570	2,595	

MÜLLER excavator-mounted vibratory hammers HFB series with fixed eccentric moment

Type			MS-1 HFB	MS-2 HFB	MS-3 HFB	MS-4 HFB	MS-6 HFB	MS-7 HFB	MS-9 HFB	MS-17 HFB
Centrifugal force	F (max.)	kN	90	245	296	374	464	604	606	604
Eccentric moment	M stat (max.)	kgm	0.7	2.2	3.0	4.2	6.5	7.0	8.5	17.0
Frequency	f (max.)	Hz	56.0	53.1	50.0	47.5	42.5	46.7	42.5	30.0
Speed	n (max.)	min ⁻¹	3,360	3,185	3,000	2,850	2,550	2,800	2,550	1,800
Pulling force	F pull (max.)	kN	34	60	60	120	120	150	150	140
Pushing force	F push (max.)	kN	34	40	40	80	80	80	80	170
Weight total	(incl. standard clamping device)	kg	350	815	830	1,230	1,240	1,300	1,380	2,445
Weight dynamic	(incl. standard clamping device)	kg	230	570	585	940	950	950	990	1,690
Amplitude	(incl. standard clamping device)	mm	6.1	7.7	10.3	8.9	13.7	14.7	17.2	20.1
Power consumption	P (max.)	kW	60 / 38	61	70	100	119	130	133	158
Required oil flow	Q Motor (max.)	l/min	102 / 64	105	120	171	204	224	229	270
Operation pressure	p (max.)	bar	350	350	350	350	350	350	350	350
Dimensions	Length L	mm	835	1,153	1,153	1,239	1,239	1,239	1,239	1,727
	Width B	mm	472	626	626	742	742	742	762	928
	Height H (incl. standard clamping device)	mm	825	1,129	1,129	1,249	1,249	1,249	1,249	1,529
	Throat T	mm	230	260	260	340	340	340	340	340
Standard clamping device	Type	MS-U	12	40	40	60/72	60/72	60/72	60/72	80/100
Recommended power pack	Type	MS-A	-	-	-	190	190	190	190	190

Equipment selection guide

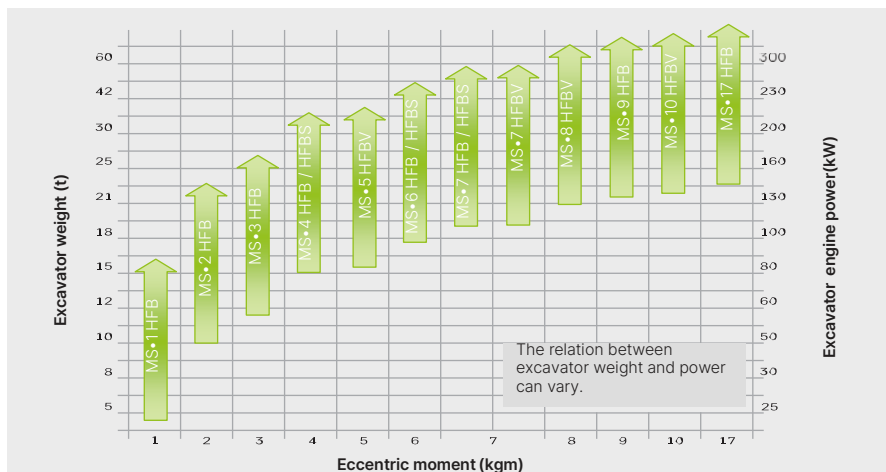

MÜLLER excavator-mounted vibratory hammers HFB S series with fixed eccentric moment

Type			MS-4 HFB S	MS-6 HFB S	MS-7 HFB S
Centrifugal force	F (max.)	kN	378	464	604
Eccentric moment	M stat (max.)	kgm	4.2	6.5	7.0
Frequency	f (max.)	Hz	47.5	42.5	46.7
Speed	n (max.)	min ⁻¹	2,850	2,550	2,800
Pulling force	F pull (max.)	kN	120	120	150
Pushing force	F push (max.)	kN	80	80	80
Weight total	(incl. standard clamping device)	kg	1,360	1,370	1,380
Weight dynamic	(incl. standard clamping device)	kg	1,110	1,120	1,130
Amplitude	(incl. standard clamping device)	mm	7.7	11.6	12.4
Power consumption	P (max.)	kW	100	119	130
Required oil flow	Q Motor (max.)	l/min	171	204	224
Operating pressure	p (max.)	bar	350	350	350
Dimensions	Length L	mm	1,520	1,520	1,520
	Width B	mm	697	697	697
	Height H (incl. standard clamping device)		1,250	1,250	1,250
	Throat T	mm	-	-	-
Standard clamping device	Type	MS-U	60/72	60/72	60/72
Recommended power pack	Type	MS-A	190	190	190

Equipment selection guide

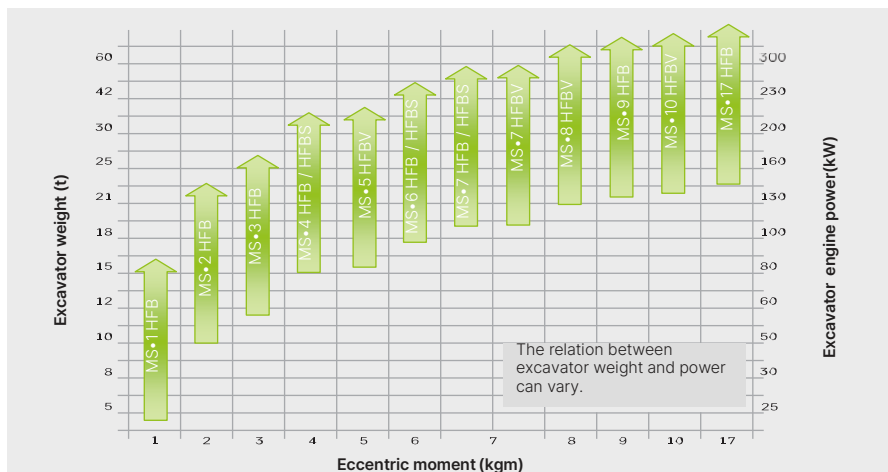

MÜLLER excavator-mounted vibratory hammers HFBV series with variable eccentric moment

Type			MS-5 HFBV*	MS-7 HFBV*	MS-8 HFBV	MS-10 HFBV
Centrifugal force	F (max.)	kN	400	478	585	588
Eccentric moment	M stat (max.)	kgm	0-5	0-6,7	0-8	0-9,8
Frequency	f (max.)	Hz	45.0	42.5	43.0	39.0
Speed	n (max.)	min ⁻¹	2,700	2,550	2,580	2,340
Pulling force	F pull (max.)	kN	120	120	150	150
Pushing force	F Push (max.)	kN	80	80	150	150
Weight total	(incl. standard clamping device)	kg	1,660	1,680	2,180	2,230
Weight dynamic	(incl. standard clamping device)	kg	1,170	1,190	1,340	1,380
Amplitude	(incl. standard clamping device)	mm	8.5	11.3	12.0	14.2
Power consumption	P (max.)	kW	95 / 126	112 / 126	165 / 120	167 / 148
Required oil flow 5-hose connection	Q Motor (max.)	l/min	162 / 216	204 / 230	283 / 206	293 / 257
Required oil flow 3-hose connection	Q Motor (max.)	l/min	180 / 240	220 / 250	-	-
Operating pressure	p (max.)	bar	350	350	350	350
Dimensions	Length L	mm	1,395	1,395	1,554	1,554
	Width B	mm	707	707	761	761
	Height H (incl. standard clamping device)		1,544	1,544	1,582	1,582
	Throat T	mm	390	390	415	415
Standard clamping device	Type	MS-U	60/72	60/72	60/72	60/72
Recommended power pack	Type	MS-A	190	190	190	190

*Option: with three or five connecting hoses

Equipment selection guide

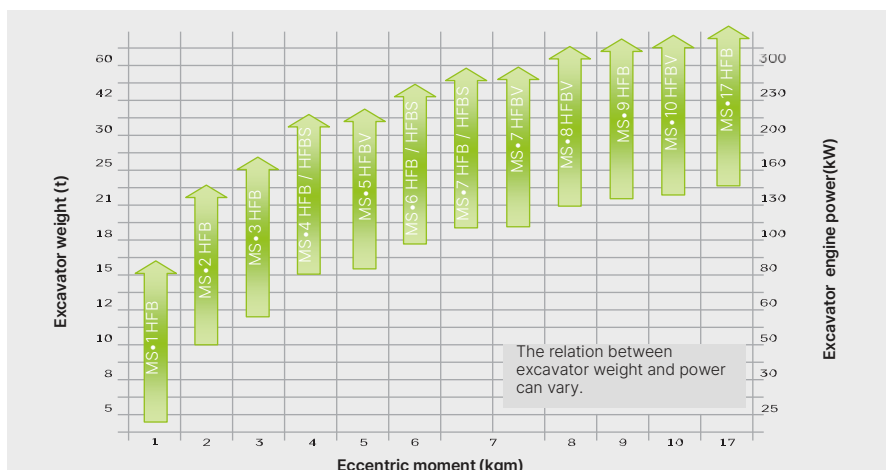

MÜLLER side-grip excavator-mounted vibratory hammers HFB SG series with fixed eccentric moment

Type			MS-4 HFB SGL	MS-4 HFB SG	MS-6 HFB SG	MS-7 HFB SG
Centrifugal force	F (max.)	kN	305	374	464	500
Eccentric moment	M stat (max.)	kgm	3.8	4.2	6.6	7.0
Frequency	f (max.)	Hz	45.0	47.5	42.5	42.5
Speed	n (max.)	min-1	2,700	2,850	2,550	2,550
Pulling force	F pull (max.)	kN	120	120	120	120
Pushing force	F Push (max.)	kN	120	120	120	120
Weight total	including lower clamping device	kg	1,840	2,245	2,255	2,260
Weight dynamic	including lower clamping device	kg	995	1,235	1,245	1,250
Amplitude	including lower clamping device	mm	7.6	6.7	10.5	11.2
Power consumption	P (max.)	kW	95 / 79	100	119	119
Required oil flow	Q motor (max.)	l/min	162 / 135	171	204	204
Operating pressure	p (max.)	bar	350	350	350	350
Dimensions	Length L	mm	1,443	1,455	1,455	1,455
	Width B	mm	1,057	1,057	1,057	1,057
	Height H (including lower clamping device)	mm	1,460	1,526	1,526	1,526
Standard clamping device	MS-U		40	60/72	60/72	60/72
Special clamping device	MS-U		60/72 K	60/72 K	60/72 K	60/72 K

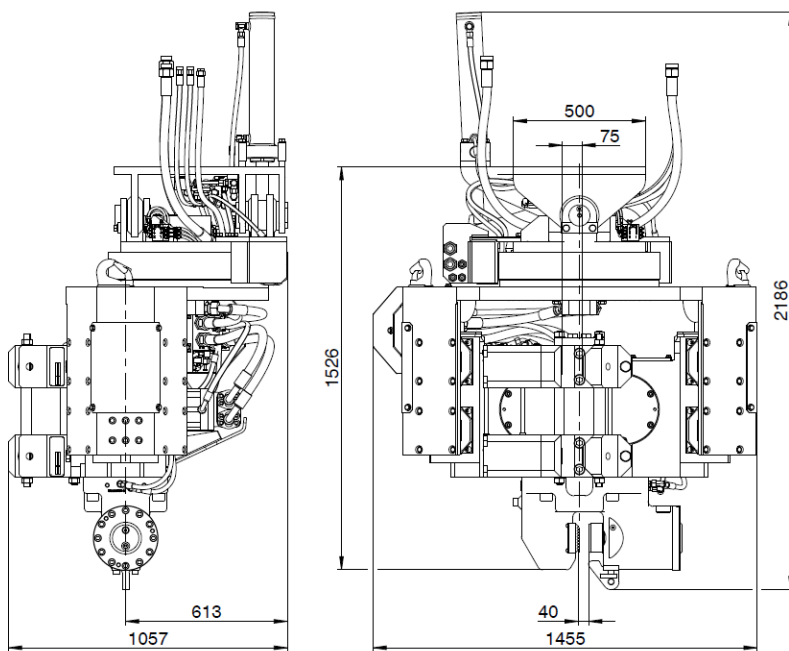

MÜLLER excavator-mounted drill drives RHA series

Type		MS-RHA 12 3*	MS-RHA 16 3*	MS-RHA 24 3*	MS-RHA 34 3*	MS-RHA 46 3*
Torque	M (max.) daNm	1,200	1,600	2,400	3,400	4,600
Speed	n (max.) min ⁻¹	125	115	110	100	70
Operating pressure	p (max.) bar	350	350	350	350	350
Required oil flow	Q motor (max.) l/min	260	350	460	600	600
Diameter	Smallest drilling diameter mm	200	200	400	400	400
Diameter	Largest drilling diameter mm	700	900	1,200	1,400	1,600
Weight	without auger/without stand kg	300	360	440	600	760
Drill depth	With smallest drilling diameter (max.) m	20	25	14	16	20
Drill depth	With largest drilling diameter (max.) m	4	4	2	2	2
Hexagon connection	mm	70 / 70	70 / 80	80 / 80	100 / 100	120 / 120

*Connection to excavator stick

Options available on request: mounted on leader, clamped into vibratory hammer clamping device

MÜLLER clamping devices

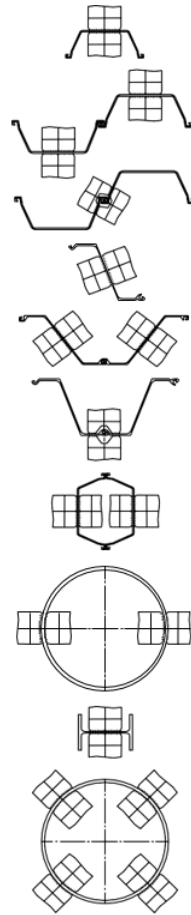
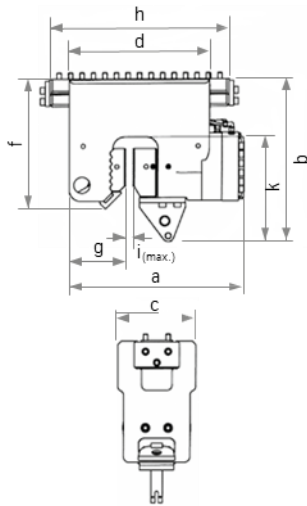

Arrangement of clamps

Type	Clamping force kN	Clamping pressure bar	Dimensions in mm							i max.	IPB min	Weight kg
			a	c	d	f	g	h				
MS-U 12*	122	260	229	195	195	223	95	-	15	120	50	
MS-U 40*	370	300	548	260	400	285	175	-	40	120	145	
MS-U 54**	540	350	648	270	515	694	190	730	22	180	440	
MS-U 60/72*	600 / 720	300 / 358	640	320	480	350	220	-	40	140	260	
MS-U 80/100 A*	800 / 1,000	280 / 350	798.5	330	519	410	216.5	-	48	280	400	
MS-U 80/100 G**	800 / 1,000	280 / 350	760	340	580	509	206.5	-	48	-	670	
MS-U 90**	900	350	770	340	580	529	290	820	28	180	515	
MS-U 150 GP**	1,500	350	892	340	640	554	309	780	45	320***	920	
MS-U 150 AP*	1,500	350	902	360	660	580	319	-	40	320***	940	
MS-U 180 GP**	1,800	350	903	390	745	645	325	880	80	320***	1,250	
MS-U 180 AP*	1,800	350	893	390	740	645	314	-	80	320***	1,130	
MS-U 250 G**	2,500	350	1,173	398	860	840	364	1,150	63	450	2,450	
MS-U 250 A*	2,500	350	1,173	395	860	840	380	-	63	450	1,950	
MS-U 360 A*	3,600	350	1,255	460	1,180	950	520	-	80	400	3,130	

* for direct bolting ** slideable on clamping bar *** IPB 300 possible with special equipment

MÜLLER accessories

Brackets

So-called X-brackets are available in various sizes for driving large-diameter, heavy, tubular piles.

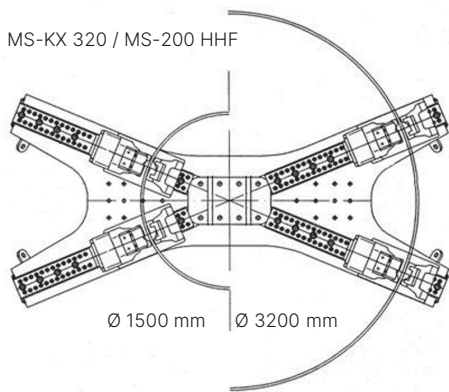

MÜLLER ground release shackle

Type	Pulling force kN	Weight kg
MS-SSZ-3 B	30	15
MS-SSZ-4 B	40	24
MS-SSZ-5 B	50	26

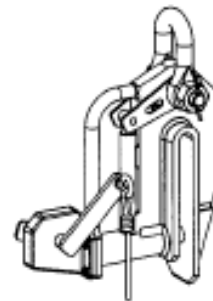

Additional accessories for excavator-mounted units

Adapter plate /double clamping devices
driving pipe piles

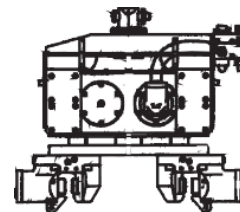

MÜLLER universal link attachment for excavator-mounted equipment

This accessory enables MÜLLER excavator-mounted vibratory hammers and drill drives to be attached to the majority of excavators. It is fitted with three different connecting pins. The benefits are the fast change over from drilling unit to vibratory hammer and the stable design. Other link attachments are available on request.

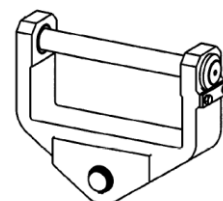

terra infrastructure GmbH, Hollestr. 7a, 45127 Essen, Germany
T: +49 201 5657832110
info@terra-infrastructure.com | www.terra-infrastructure.com

Australia

terra infrastructure Pty Ltd, 11 Woodford Pl, Thornton NSW 2322, Australia
P: +61 2 8448-3555
Info.anz@terra-infrastructure.com
www.terra-infrastructure.com.au

New Zealand

terra infrastructure Pty Ltd, 180 Fred Taylor Drive, Whenuapai Auckland 0814, New Zealand
P: +64 9 416-8891
Info.anz@terra-infrastructure.com
www.terra-infrastructure.co.nz

Baltic States

terra infrastructure UAB, Liepų str. 83, 93269 Klaipėda, Lithuania
P: +370 46 355-401
www.terra-infrastructure.com/lt

Russian Federation

OOO terra infrastructure, Bolshevnikov Str. 54 B, Office 211, 193315 St. Petersburg, Russia
P: +7 812 337-6510
www.terra-infrastructure.com/ru

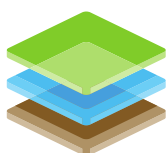

terra
infrastructure